

CV-57KJ2

**HDMI extender over single cat.X with
bi-directional IR, and Auto EDID Learning**

User Manual



To avoid EMI issue, complete STP Cat6 cable is strongly recommended!



rev: 121101
Made in Taiwan



Safety and Notice

The **CV-57KJ2 HDMI extender over single cat.X with bi-directional IR, and Auto EDID learning** has been tested for conformance to safety regulations and requirements, and has been certified for international use. However, like all electronic equipments, the **CV-57KJ2** should be used with care. Please read and follow the safety instructions to protect yourself from possible injury and to minimize the risk of damage to the unit.

- Follow all instructions and warnings marked on this unit.
- Do not attempt to service this unit yourself, except where explained in this manual.
- Provide proper ventilation and air circulation and do not use near water.
- Keep objects that might damage the device and assure that the placement of this unit is on a stable surface.
- Use only the power adapter and power cords and connection cables designed for this unit.
- Do not use liquid or aerosol cleaners to clean this unit. Always unplug the power to the device before cleaning.



TABLE OF CONTENTS

INTRODUCTION.....	1
FEATURES.....	1
SPECIFICATIONS.....	2
PANEL DESCRIPTIONS.....	3
Transmitting unit ► CV-57KJ2-TX.....	3
Receiving unit ► CV-57KJ2-RX	4
PACKAGE CONTENTS	5
CONNECTION DIAGRAM	5
IR PASS-THROUGH.....	6
HARDWARE INSTALLATION.....	7
EDID LEARNING.....	7
PIN DEFINITION	8
NOTICE	9
WARRANTY	10

INTRODUCTION

The **CV-57KJ2 HDMI extender over single cat.X with bi-directional IR, and Auto EDID Learning** boosts up your video/audio transmission distance up to 50m (165ft) in HDTV 1080i format, 40m (130ft) in HDTV 1080p format, and 20m (65ft) in HDTV 1080p with 36-bit color depth. **CV-57KJ2** also supports the most advanced 3D video format and therefore guarantees the highest 3D video compatibility on the market. With only one cost effective Cat.5/5e/6 cable, users can readily extend HDTV sources from DVD players, Blu-ray Disc player, PS3, PC, and any other kinds of sources compliant with TMDS to distant display monitors including HDMI or DVI enabled TV sets or LCD PC monitors. With the advanced design for the latest HDMI technology, deep color video, DTS-HD Master Audio or Dolby TrueHD audio, and HDCP supports and compatibility are all further insured. This flexibility makes HDCP compliant DVD players or PS3 transmit utmost high quality video and audio with a greater distance at the minimal cost, when integrating several components apart. In addition, **CV-57KJ2** is also equipped with bi-directional IR pass-through path. These bonus feature allows users to boost IR control distance up to 100m (330 ft) and makes IR control possible through only single Cat.5/5e/6 cable including HDMI signals. In addition, serial port offers the convenient path for interactive application, such as touch panels.

The **CV-57KJ2** includes two units: transmitting unit **CV-57KJ2-TX** and receiving unit **CV-57KJ2-RX**. The transmitting unit is used to capture the input HDMI / DVI signals with IR control packets and carry the signals via one cost effective Cat.5/5e/6 cable. The receiving unit is responsible for equalizing the transmitted HDMI signal and reconstructing IR signals. The transmission distance between the sending and receiving units can be up to 50m (165ft) at HD 720p or 1080i; or 40m (130ft) at Full HD 1080p. With an 8-level equalization rotary control on the receiving unit, users can adjust the equalization strength to the received HDMI signals accordingly, and therefore optimize the transmission distance between source and destination.

FEATURES

- Support HDMI Deep Color & full 3D
- Extends the transmission up to 50m (165ft) from the HDMI source at HD 1080i or 720p 24-bit
- Extends the transmission up to 40m (130ft) from the HDMI source at Full HD 1080p 24-bit
- Extends the transmission up to 20m (65ft) from the HDMI source at Full HD 1080p 36-bit
- HDCP 1.1 compliant
- Auto EDID learning feature
- Minimizes the cable skew by adjustable 8-level equalization control
- Pure unaltered uncompressed 7.1ch digital HDMI over Cat.5/5e/6 cable transmission
- DTS-HD and Dolby TrueHD high bit rate audio support
- Supports full frequency IR signal from 20KHz to 60KHz
- Bi-directional IR path
- Allows cascading
- Wall mounting housing design for easy and robust installation
- Perfectly integrated with other HDMI over CAT5 series products



1. The claimed transmission distance here is subject to the grade of installed cable(s), source device and display.
2. For over CAT5/COAX transmission, the cable(s) has to be solid, not stranded. Any keystone jack along the transmission path will kill the transmission performance significantly!

SPECIFICATIONS

Model Name	CV-57KJ2	
Technical	CV-57KJ2[Tx]	CV-57KJ2[Rx]
Role of usage	Transmitter [TX]	Receiver [RX]
HDMI compliance	HDMI Deep Color & full 3D	
HDCP compliance	Yes	
Video bandwidth	Single-link 225MHz [6.75Gbps]	
Video support	480i / 480p / 720p / 1080i / 1080p60	
HDMI over UTP transmission [24-bit]	Full HD (1080p)-40m (130ft) [CAT.X] HD (720p/1080i)-50m (165ft) [CAT.X]	
Audio support	Surround sound (up to 7.1ch) or stereo digital audio	
Signal Equalization	8-level digital control at RX	
Input TMDS signal	1.2 Volts [peak-to-peak]	
Input DDC signal	5 Volts [peak-to-peak, TTL]	
ESD protection	[1] Human body model — ±19kV [air-gap discharge] & ±12kV [contact discharge] [2] Core chipset — ±8kV	
PCB stack-up	4-layer board [impedance control — differential 100Ω; single 50Ω]	
IR pass-thru	Full-duplex bi-directional	
RS-232 support	Yes	
Input	1x HDMI + 1x 3.5mm	1x RJ45 + 1x 3.5mm
Output	1x RJ45 + 1x 3.5mm	1x HDMI + 1x 3.5mm
In/ Out	1x DIN9	1x DIN9
HDMI source control	Controllable via IR pass-through from RX to TX and from TX to RX with IR extenders	
IR remote control	Electro-optical characteristics: $\tau = 25^\circ$ / Carrier frequency: 20-60kHz	
HDMI connector	Type A [19-pin female]	
Min DIN connector	DIN-9	
RJ45 connector	WE/SS 8P8C with 2 LED indicators	
3.5mm connector	IR blaster & IR receiver	
Rotary control switch	EDID Mode selection	Signal level equalization
Mechanical		
Housing	Metal enclosure	
Dimensions [L x W x H]	Model	71 x 91 x 35mm [2.8" x 3.6" x 1.4"]
	Package	270 x 175 x 80mm [10.6" x 6.9" x 3.1"]
	Carton	450 x 370 x 300mm [1'6" x 1'3" x 11.8"]
Weight	Model	239g [8.4oz]
	Package	1000g [2.2 lbs]
Fixedness	Wall-mounting case with screws	
Power supply	5V 2A DC	
Power consumption	1.5 Watts	
Operation temperature	0~40°C [32~104°F]	
Storage temperature	-20~60°C [-4~140°F]	
Relative humidity	20~90% RH [no condensation]	

PANEL DESCRIPTIONS

Transmitting unit ► CV-57KJ2-TX

Front Panel

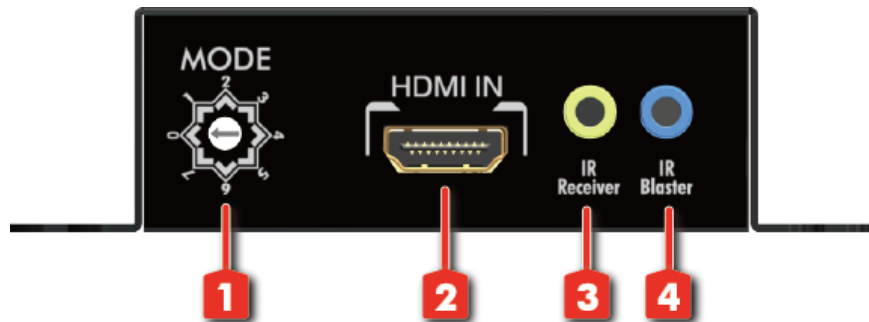

- 1. MODE:** 0 - EDID Full-HD(1080p@60) - 24bit 2D video & 7.1ch audio
1 - EDID Full-HD(1080p@60) - 24bit 2D video & 2ch audio
2 - EDID Full-HD(1080p@60) - 36bit 2D video & 7.1ch audio
3 - EDID Full-HD(1080p@60) - 36bit 2D video & 2ch audio
4 - EDID HD(1080p@30)(1080i@60)(720p@60) - 24bit 2D video & 7.1ch audio
5 - EDID HD(1080p@30)(1080i@60)(720p@60) - 24bit 2D video & 2ch audio
6 - EDID Full-HD(1080p@60) - 36bit 3D video & 2ch audio
7 - Auto EDID learning/ Manual EDID learning mode
- 2. HDMI IN:** Connects to a HDMI source with a HDMI male-male cable
- 3. IR Receiver:** Infrared 3.5mm socket for plugging in the extension cable of IR receiver
- 4. IR Blaster:** Infrared 3.5mm socket for plugging in the extension cable of IR blaster

Rear Panel

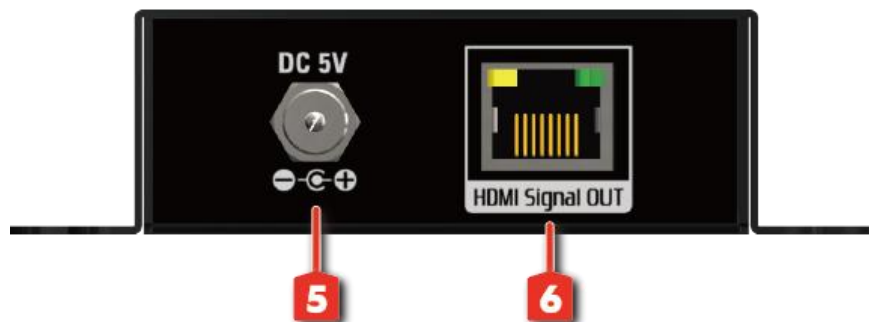

- 5. +5V DC:** Connect to 5V DC power supply.
- 6. HDMI Signal OUT:** Plug in a Cat-5/5e/6 cable that needs to be linked to the transmitting unit CV-57KJ-TX.

Receiving unit ► CV-57KJ2-RX

Front Panel

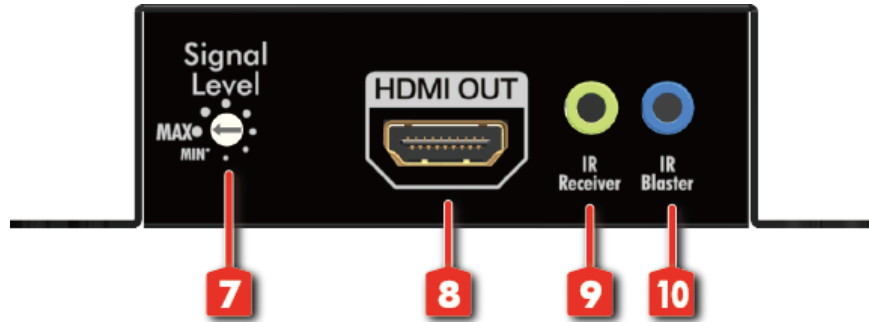

- 7. Signal Level:** Adjust the 8-level equalization control to the received HDMI signals. The HDMI signal level varies from MAX (strongest) to MIN (weakest) for respective transmission length from longest possible range to short distance. Please adjust the signal level from MIN to MAX and stop turning the rotary switch whenever the audio/video is playing normally. Inappropriate signal level setting may cause overpowering issue that would shorten the product life significantly!
- 8. HDMI OUT:** Connect to a HDMI display with a HDMI male-male cable.
- 9. IR Receiver:** Infrared 3.5mm socket for plugging in the extension cable of IR receiver
- 10. IR Blaster:** Infrared 3.5mm socket for plugging in the extension cable of IR blaster

Rear Panel

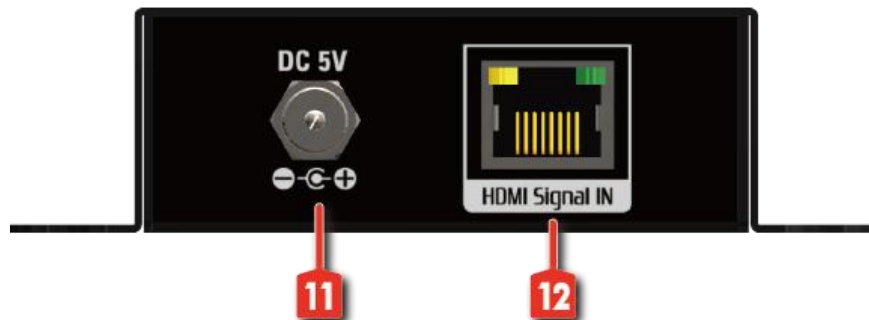

- 11. +5V DC:** Connect to 5V DC power supply.
- 12. HDMI Signal IN:** Plug in a Cat-5/5e/6 cable that needs to be linked to the receiving unit CV-57KJ-RX.

PACKAGE CONTENTS

- 1x CV-57KJ2 [TX & RX]
- 1x IR blaster
- 1x IR receiver
- 2x DC 5V 2A wall wart
- 1x User Manual

CONNECTION DIAGRAM

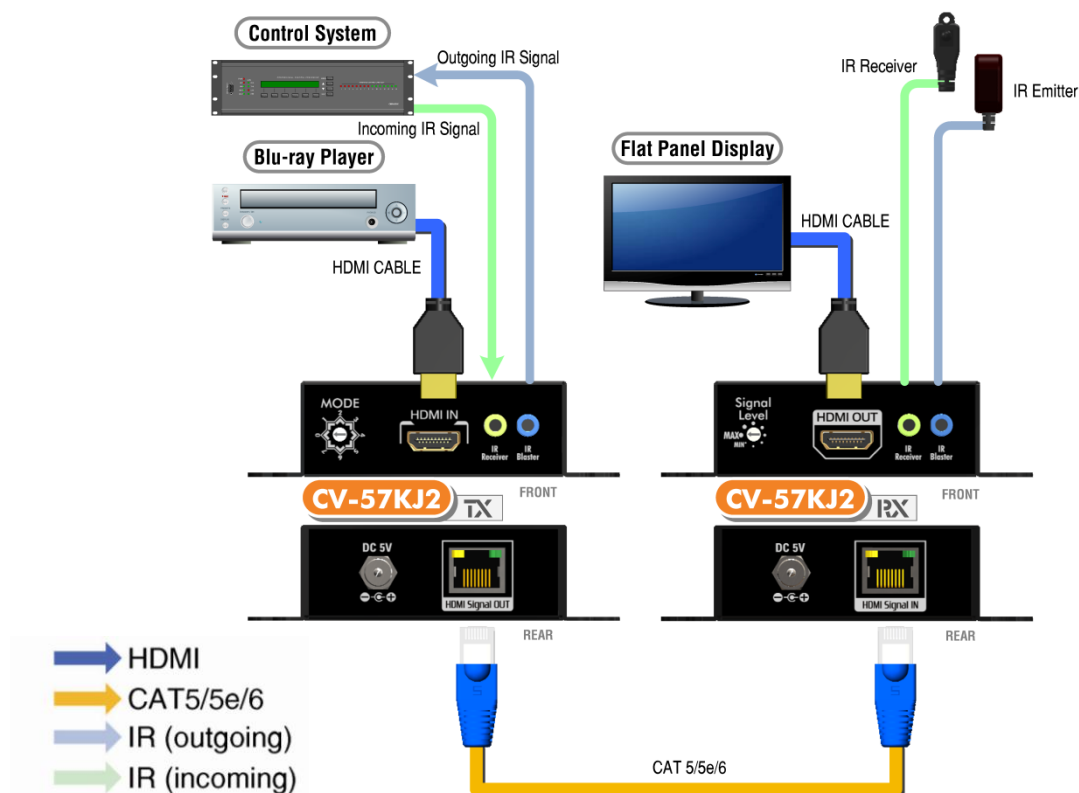

IR PASS-THROUGH

IR Extenders

IR Blaster



IR Receiver



IR Sockets

IR BLASTER: plug in the IR blaster to emit all IR command signals received from the IR receiver from the other end to control the devices corresponding to the IR signals.

IR RECEIVER: plug in the IR receiver to receive all IR command signals from the IR remote controls of the corresponding devices.

CAUTION!

Incorrect placement of IR Blaster and Receiver may result in the failure of the IR extenders. Please check carefully before plugging in the IR extender to the respective IR sockets. Warranty will not cover the damage.

Definition of IR Earphone Jack

IR Blaster

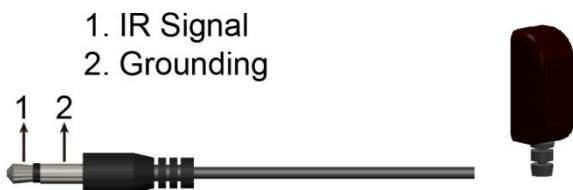

IR Receiver

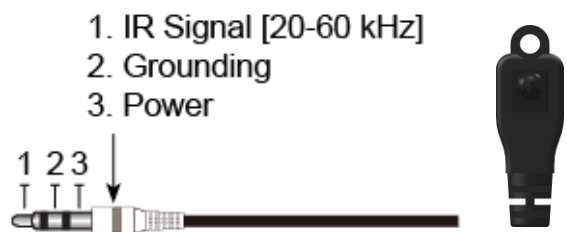

You can buy any IR extension cables in the market that are compatible to the definition of the IR sockets for the matrix if necessary for replacement use. However, IR cables longer than 2m (6-ft) may not work.

HARDWARE INSTALLATION

1. Connect a HDMI or DVI source (such as a Blu-ray Disc player) to the transmitting unit CV-57KJ2-TX.
2. Connect a HDMI or DVI display (such as a LCD TV) to the receiving unit CV-57KJ2-RX.
3. Connect IR Blaster/Receiver to both TX and RX units.
4. Connect a Cat-5/5e/6 cable between the transmitting and receiving units.
5. Make sure this Cat-5/5e/6 cable is tightly connected and not loose.
6. Plug in 5V DC power supply unit to the power jack of the receiving unit CV-57KJ2-RX.
7. Plug in 5V DC power supply unit to the power jack of the transmitting unit CV-57KJ2-TX.
8. If you see flickering or blinking image on the display, please adjust the rotary control switch to improve the cable skew. MAX stands for the strongest HDMI signal level for longest possible transmission length while MIN stands for the weakest HDMI signal level for short transmission length. Please adjust the signal level from MIN to MAX and stop turning the rotary switch whenever the audio/video is playing normally. Inappropriate signal level setting may cause overpowering issue that would shorten the product life significantly!

EDID LEARNING

Auto EDID Learning Mode

1. Set "**MODE**" on the transmitting unit CV-57KJ2-TX at **7**
2. Follow the instruction in [Hardware Installation] to set up the CV-57KJ2
3. The LED on the RJ45 of CV-57KJ2-TX will dim and light again, which indicates the EDID learning procedure is complete.

Manual EDID Learning Mode

1. Turn off CV-57KJ2-TX and disconnect the Cat.5/5e/6 between CV-57KJ2-TX and CV-57KJ2-RX.
2. Connect the HDMI display to "**HDMI IN**" on the CV-57KJ2-TX with a HDMI cable.
3. Set "**MODE**" on the transmitting unit CV-57KJ2-TX at **7**.
4. Turn on the CV-57KJ2-TX.
5. The LED on the RJ45 of CV-57KJ2-TX will dim and light again, which indicates the EDID learning procedure is complete.
6. Unplug the HDMI cable from the display and follow the instruction in [Hardware Installation] to set up the CV-57KJ2 and enjoy the experience.



After you use "Manual EDID Learning" steps at Mode 7 on the TX, the "Auto EDID Learning" function will be closed temporarily until you set the "MODE" on the TX to other mode and then back to mode 7 again.

PIN DEFINITION

HDMI

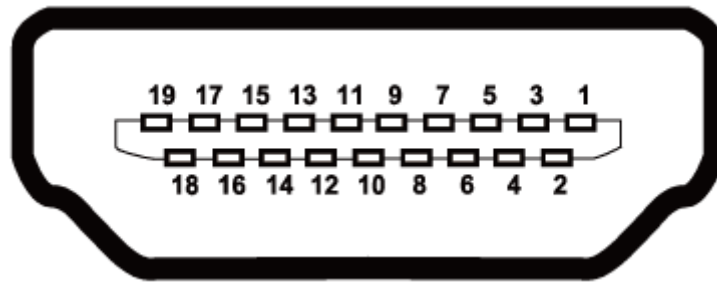

Type A (Receptacle) HDMI

Pin 1	TMDS Data2+	Pin 11	TMDS Clock Shield
Pin 2	TMDS Data2 Shield	Pin 12	TMDS Clock-
Pin 3	TMDS Data2-	Pin 13	CEC
Pin 4	TMDS Data1+	Pin 14	Reserved (N.C. on device)
Pin 5	TMDS Data1 Shield	Pin 15	SCL
Pin 6	TMDS Data1-	Pin 16	SDA
Pin 7	TMDS Data0+	Pin 17	DDC/CEC Ground
Pin 8	TMDS Data0 Shield	Pin 18	+5V Power
Pin 9	TMDS Data0-	Pin 19	Hot Plug Detect
Pin 10	TMDS Clock+		

CAT5 [RJ45]

Data Link TIA/EIA-568-B		
PIN	Color	Function
1	W-O	TX0-
2	O	TX0+
3	W-G	TX1-
4	BL	TX2-
5	W-BL	TX2+
6	G	TX1+
7	W-BR	TXC-
8	BR	TXC+

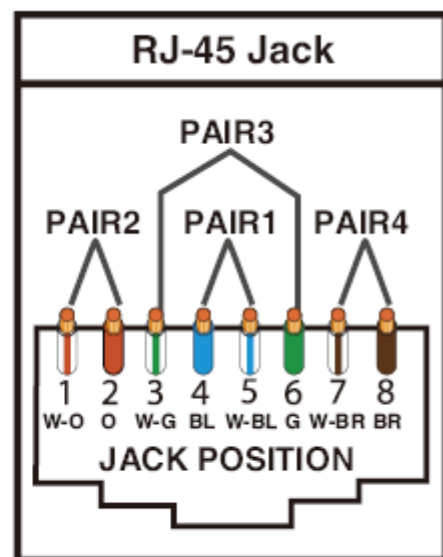

NOTICE

1. When adjusting the signal level on the receiver unit, please dial the rotary control switch from MIN to MAX and stop turning the rotary switch whenever the audio/video is playing normally. Inappropriate signal level setting may cause overpowering issue that would shorten the product life significantly!
2. Wrongly insert IR blaster and IR receiver to wrong 3.5mm infrared sockets may result in the failure of the IR extenders. Please check carefully before plugging in the IR extender to the respective IR sockets.
3. If the DVI or HDMI device requires the EDID information, please use EDID Reader/Writer to retrieve and provide DVI or HDMI display EDID information.
4. All HDMI over CAT5 transmission distances are measured using Belden 1583A CAT5e 125MHz UTP cable and ASTRODESIGN Video Signal Generator VG-859C & VG-870B.
5. The transmission length is largely affected by the type of Cat-5/5e/6 cables, the type of HDMI sources, and the type of HDMI display. The testing result shows solid UTP cables (usually in the form of 300m [1,000ft] bulk cables) can transmit a lot longer signals than stranded UTP cables (usually in the form of fixed length patch cords). Shielded STP cables are better suited than unshielded UTP cables. A solid UTP Cat-5e cable shows longer transmission range than stranded STP Cat-6 cable. For long extension applications, solid UTP/STP cables are the only viable choice.
6. EIA/TIA-568-B termination (T568B) for Cat-5/5e/6 cables is recommended for better performance.
7. To reduce the interference among the unshielded twisted pairs of wires in Cat-5/5e/6 cable, one can use shielded STP cables to improve EMI problems, which is worsen in long transmission.
8. Because the quality of the CAT5/6 cables has the major effect on how long the transmission limit can achieve and how good is the received picture quality, the actual transmission range is subject to one's choice of Cat-5/5e/6 cables. For desired resolutions greater than 1080i or 1280x1024, a Cat-6 cable is recommended.
9. If your HDMI display has multiple HDMI inputs, it is found that the first HDMI input [HDMI input #1] generally can produce better transmission performance among all HDMI inputs.



WARRANTY

The SELLER warrants the **CV-57KJ2 HDMI extender over single cat.X with bi-directional IR, and Auto EDID Learning** free from defects in the material and workmanship for 1 year from the date of purchase from the SELLER or an authorized dealer. Should this product fail to be in good working order within 1 year warranty period, The SELLER, at its option, repair or replace the unit, provided that the unit has not been subjected to accident, disaster, abuse or any unauthorized modifications including static discharge and power surge. This warranty is offered by the SELLER for its BUYER with direct transaction only. This warranty is void if the warranty seal on the metal housing is broken.

Unit that fails under conditions other than those covered will be repaired at the current price of parts and labor in effect at the time of repair. Such repairs are warranted for 90 days from the day of reshipment to the BUYER. If the unit is delivered by mail, customers agree to insure the unit or assume the risk of loss or damage in transit. Under no circumstances will a unit be accepted without a return authorization number.

The warranty is in lieu of all other warranties expressed or implied, including without limitations, any other implied warranty or fitness or merchantability for any particular purpose, all of which are expressly disclaimed.

Proof of sale may be required in order to claim warranty. Customers outside Taiwan are responsible for shipping charges to and from the SELLER. Cables and power adapters are limited to a 30 day warranty and must be free from any markings, scratches, and neatly coiled.

The content of this manual has been carefully checked and is believed to be accurate. However, The SELLER assumes no responsibility for any inaccuracies that may be contained in this manual. The SELLER will NOT be liable for direct, indirect, incidental, special, or consequential damages resulting from any defect or omission in this manual, even if advised of the possibility of such damages. Also, the technical information contained herein regarding the **CV-57KJ2** features and specifications is subject to change without further notice.